



HAYASHI-REPIC

PWM Controller

LPWP-DGC100R-TP-8CH

Input power : AC100~240V (50/60Hz) 240VA

Weight : 1400g or less

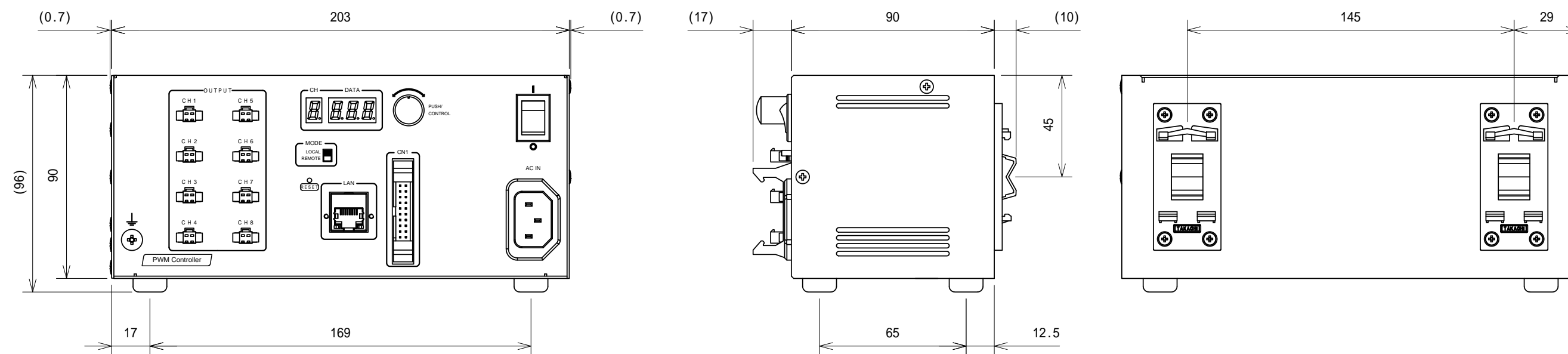

UNIT : mm