



HAYASHI-REPIC

PWM Controller

LPWP-DGC150R-TP-4CH-24-T

Input power : DC24V ±5% 6.25A(MAX)

Weight : 1000g or less

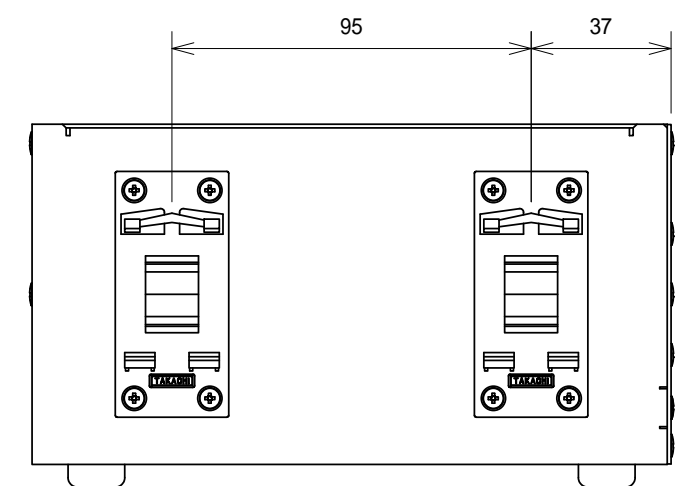
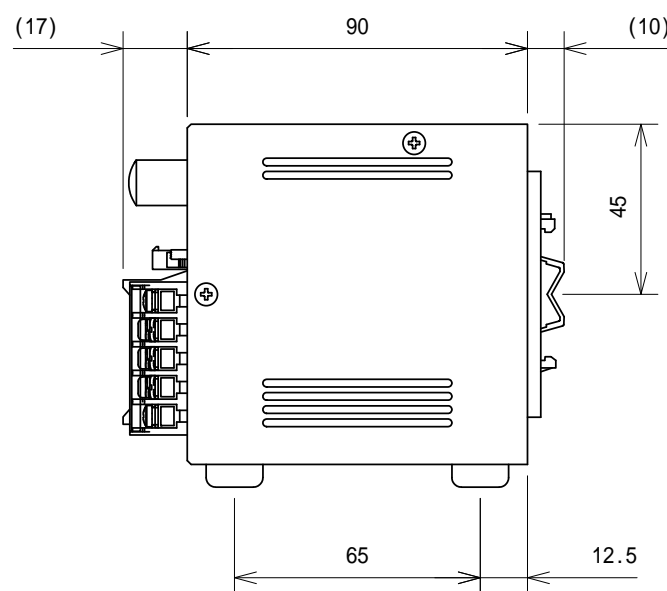
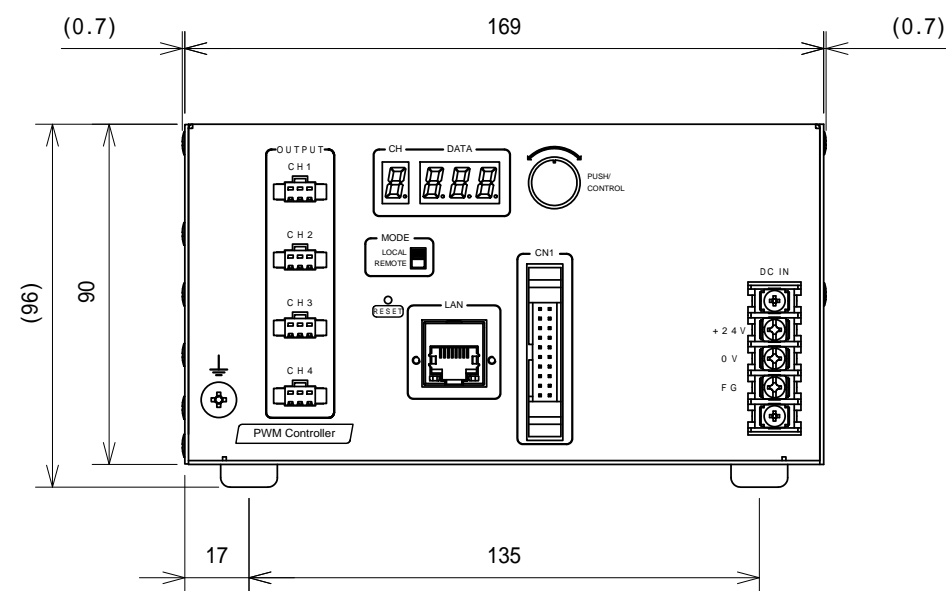

UNIT : mm