



HAYASHI-REPIC

PWM Controller

LPWP-DGC50R-TP-2CH-24-T

Input power : DC24V ±5% 2.08A(MAX)

Weight : 600g or less

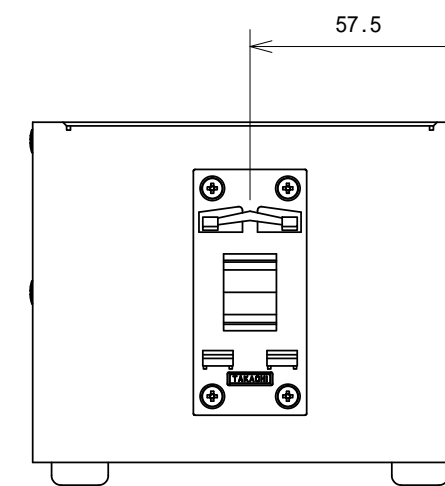
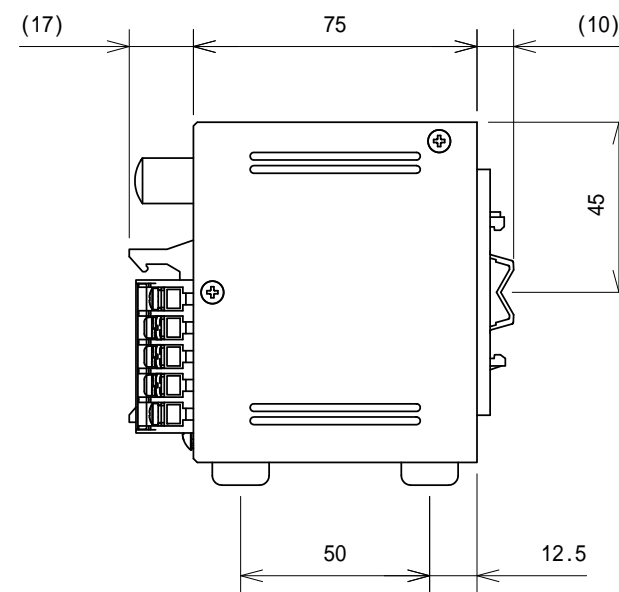
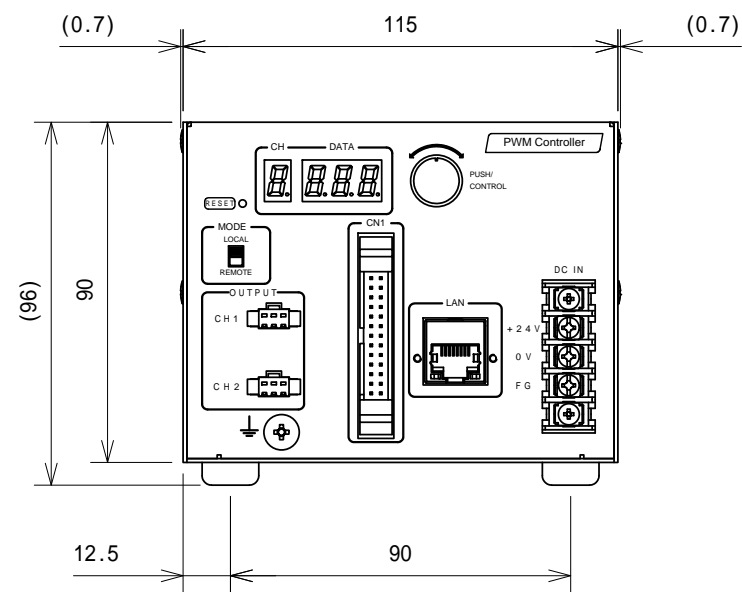

UNIT : mm